

TRA93P

Cooker size	90x60 cm
N. of cavities with energy label	3
Hob type	Gas
Type of main oven	Thermoseal
Type of second oven	Fan assisted
Cleaning system main oven	Vapour Clean
EAN code	8017709184155



Aesthetics



Aesthetic	Victoria	Display	electronic 5 buttons
Colour	Cream	Colour of buttons	Black
Design	Victoria	No. of controls	10
Door	With frame	Serigraphy colour	Black
Upstand	Yes	Handle	Smeg Victoria
Type of pan stands	Cast Iron	Handle Colour	Brushed stainless steel
Hob colour	Black enamel	Glass type	Black
Command panel finish	Enamelled metal	Plinth	Anthracite
Control knobs	Smeg Victoria	Logo	assembled 50's
Controls colour	Stainless steel	Logo position	Upstand

Programs / Functions

No. of cooking functions 5

Traditional cooking functions

 Static  Fan assisted  Circulaire

 Eco  Fan assisted bottom

Cleaning functions

 Vapour Clean

Other functions



Programs / Functions Third Oven

No. of functions third oven

1

Oven light



Full grill



Hob technical features

UR

Total no. of cook zones 6

Front right - Gas - Semi Rapid - 1.80 kW

Rear right - Gas - Rapid - 1.85 kW

Front centre - Gas - AUX - 1.00 kW

Rear centre - Gas - Semi Rapid - 1.30 kW

Rear left - Gas - AUX - 1.60 (BBQ) kW

Front left - Gas - UR - 4.20 kW

Type of gas burners Standard

Gas safety valves

Yes

Automatic electronic ignition Yes

Burner caps

Matt black enamelled

Main Oven Technical Features



No. of lights

1

Net volume of the cavity 63 l

Gross volume, 1st cavity 68 l

Cavity material Ever Clean enamel

No. of shelves 4

Type of shelves Metal racks

Light type Halogen

Light Power 40 W

Cooking time setting Start and Stop

Door opening Side opening

Side opening door Yes

Removable door Yes

Full glass inner door Yes

Removable inner door Yes

Total no. of door glasses 3

No. of thermo-reflective door glasses 1

Safety Thermostat Yes

Usable cavity space dimensions (HxWxD) 316x444x425 mm

Temperature control Electro-mechanical

Lower heating element power 1200 W

Upper heating element - Power 1000 W

Grill element 1700 W

Large grill - Power 2700 W

Circular heating element - Power 2000 W

Grill type Electric

Tilting grill Yes

Options Main Oven

Timer	Yes	Minimum Temperature	50 °C
End of cooking acoustic alarm	Yes	Maximum temperature	260 °C

Second Oven Technical Features



Net volume of the second cavity	66 l	Full glass inner door	Yes
Gross volume, 2nd cavity	68 l	Removable inner door	Yes
Cavity material	Ever Clean enamel	No. total door glasses	2
No. of shelves	9	No. thermo-reflective door glasses	1
Type of shelves	Metal racks	Safety Thermostat	Yes
No. of lights	1	Cooling system	Tangential
Light type	Halogen	Usable cavity space dimensions (HxWxD)	605x275x370 mm
Light Power	40 W	Temperature control	Electro-mechanical
Door opening	Side opening	Circular heating element - Power	2500 W
Side opening door	Yes	Grill type	Electric
Removable door	Yes		

Options Auxiliary Oven

Minimum Temperature	50 °C	Maximum temperature	245 °C
---------------------	-------	---------------------	--------

Third Oven Technical Features



Net volume, 3rd cavity	36 l	Removable inner door	Yes
Gross volume, 3rd cavity	41 l	No. total door glasses	3
Cavity material	Ever Clean enamel	No. of thermo-reflective door glasses	1
No. of shelves	2	Safety Thermostat	Yes
Type of shelves	Metal racks	Cooling system	Tangential
No. of lights	1	Usable cavity space dimensions (HxWxD)	169x440x443 mm
Light type	Halogen	Temperature control	Electro-mechanical
Light Power	40 W	Large grill - Power	2700 W
Door opening	Flap down	Grill type	Electric
Removable door	Yes	Tilting grill	Yes
Full glass inner door	Yes		

Options Third Oven

Minimum Temperature 50 °C

Maximum temperature 260 °C

Accessories included for Main Oven & Hob



Cast iron wok support	1	40mm deep tray	1
Moka stand in cast iron	1	Grill mesh	1
TOP Oven grid with back stop	2	Telescopic Guide rails, partial Extraction	1

Accessories included for Secondary Oven



Oven grid with back stop	4	Grill mesh	1
Wide baking tray	1	Plate rack/warmer	1

Accessories included for Third Oven

Rack with back and side stop	1	40mm deep tray	1
------------------------------	---	----------------	---

Electrical Connection

Plug	(I) Australia	Type of electric cable installed	Yes, Single phase
Electrical connection rating	8300 W	Type of electric cable	Yes, Double and Three Phase
Current	36 A	Frequency	50/60 Hz
Voltage	220-240 V	Terminal block	5 poles
Voltage 2 (V)	380-415 V		

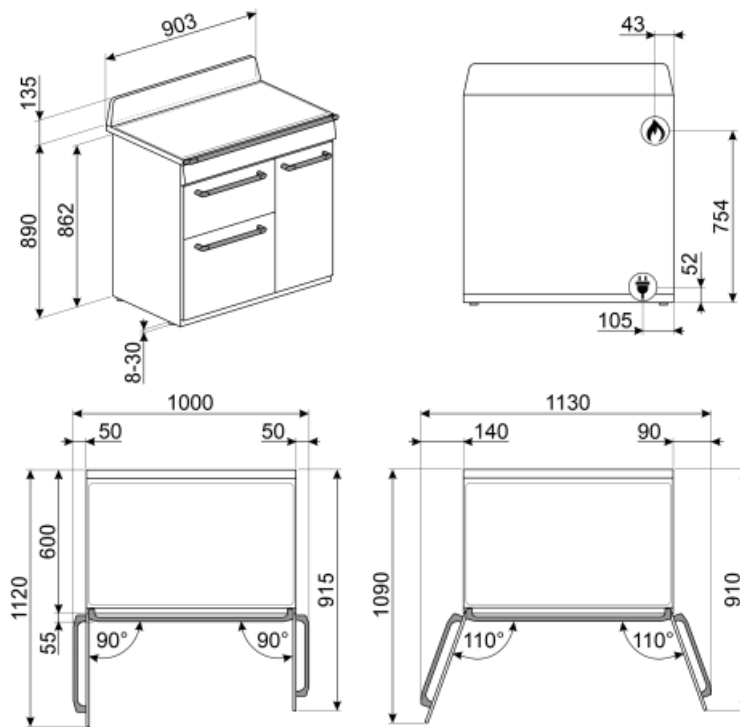

Not included accessories

AIRFRY

Air fryer rack AIRFRY . Ideal for recreating traditional frying in the oven, but with fewer calories and less fat. It allows you to cook quickly and simply dishes such as French fries, fried vegetables and fish, ensuring perfect browning and crispiness.



GTP

Partially extractable telescopic guides (1 level) Extraction: 300 mm Material: Stainless steel AISI 430 polished



BNP608T

Teflon-coated tray, 8mm depth, to be placed on the grid



BN620-1

Enamelled tray, 20mm deep



BBQ

Double sided plate BBQ. Suitable for recreating succulent and crispy dishes in the oven with the typical taste of grilled cooking. The ribbed side is particularly suitable for meats and cheeses. The smooth side for fish, seafood and vegetables.



GTT

Totally extractable telescopic guides (1 level) Extraction: 433 mm Material: Stainless steel AISI 430 polished



SMOLD

Set of 7 silicone moulds for ice creams, ice lollies, pralines, ice cubes or to portion food. Usable from -60°C to +230°C

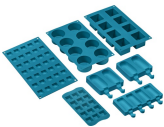

SFLK1

Child lock



PRTX

Refractory pizza stone with handles. D=35cm Not suitable for microwave ovens. Suitable for gas ovens, to be put on the griddle.



KIT1TR9N

Splashback, 90x75 cm suitable for TR9 Victoria cookers, black

KITH93

Height extension kit (950 mm), suitable for TR93 cookers



PALPZ

Pizza shovel with fold away handle width: 315mm length : 325mm



























BN640

Enamelled tray, 40mm deep



Symbols glossary (TT)

 <p>Heavy duty cast iron pan stands: for maximum stability and strength.</p>	 <p>Air cooling system: to ensure a safe surface temperatures.</p>
 <p>With the switch on this symbol, no heating is possible even if the thermostat is turned.</p>	 <p>Double glazed doors: Number of glazed doors.</p>
 <p>Triple glazed doors: Number of glazed doors.</p>	 <p>Enamel interior: The enamel interior of all Smeg ovens have a special antacid lining which helps keep the interior clean by reducing the amount of cooking grease adhering to it.</p>
 <p>Circogas: In gas ovens the fan distributes the heat quickly and evenly throughout the oven cavity, avoiding flavour transfer when cooking a number of different dishes at the same time. In electric ovens this combination completes cooking more quickly of foods that are ready on the surface, but that require more cooking inside, without further browning.</p>	 <p>Fan with upper and lower elements: The elements combined with the fan aim to provide more uniform heat, a similar method to conventional cooking, so pre-heat is required. Most suitable for items requiring slow cooking methods.</p>
 <p>Upper and lower element only: a traditional cooking method best suited for single items located in the centre of the oven. the top pf the oven will always be hottest. Ideal for roast, fruit cakes, bread etc.</p>	 <p>Circulaire: The combination of the fan and circular element around it gives a hot air cooking method. This provides many benefits including no preheat if cook time is more than 20 minutes, no flavour transfer when cooking different foods at the same time, less energy, and shorter cook times. Good for all types of food.</p>
 <p>ECO: The combination of the grill, fan and lower element is particularly suitable for cooking small quantities of food.</p>	 <p>Grill element: Using of grill gives excellent results when cooking meat of medium and small portions, especially when combined with a rotisserie (where possible). Also ideal for cooking sausages and bacon.</p>
 <p>Light</p>	 <p>All glass inner door: All glass inner door, a single flat surface which is simple to keep clean.</p>
 <p>The inner door glass: can be removed with a few quick movements for cleaning.</p>	 <p>Side lights: Two opposing side lights increase visibility inside the oven.</p>
 <p>Warming up: An option for dish warming and keeping the prepared meals hot.</p>	 <p>The oven cavity has 2 different cooking levels.</p>
 <p>The oven cavity has 4 different cooking levels.</p>	 <p>The oven cavity has 9 different cooking levels.</p>
 <p>Telescopic rails: allow you to pull out the dish and check it without having to remove it from the oven entirely.</p>	 <p>Electronic control: Allows you to maintain temperature inside the oven with the precision 2-3 ° C. This enables to cook meals that are very sensitive to temperature changes, such as cakes, souffles, puddings.</p>
 <p>Tilting grill: the tilting grill can be easily unhooked to move the heating element and clean the roof of the appliance in one simple step.</p>	 <p>Ultra rapid burners: Powerful ultra rapid burners offer up to 5kw of power.</p>



Vapour Clean: a simple cleaning function using steam to loosen deposits in the oven cavity.



The capacity indicates the amount of usable space in the oven cavity in litres.



The capacity indicates the amount of usable space in the oven cavity in litres.



The capacity indicates the amount of usable space in the oven cavity in litres.