

TRA90SG-9

Cooker size	90x60 cm
N. of cavities with energy label	1
Cavity heat source	ELECTRICITY
Hob type	Gas
Type of main oven	Thermoseal
Cleaning system main oven	Vapour Clean
EAN code	8017709297657











Aesthetics



Aesthetic	Victoria	Colour of buttons	Black
Colour	Slate Grey	No. of controls	8
Finishing	Glossy	Serigraphy colour	Silver
Design	Victoria	Handle	Smeg Victoria
Door	With frame	Handle Colour	Polished chrome
Upstand	Yes	Glass type	Black
Type of pan stands	Cast Iron	Feet	none
Hob colour	Black enamel	Plinth	Anthracite
Command panel finish	Enamelled metal	Storage compartment	Drawer
Control knobs	Smeg Victoria	Sliding compartment	Yes
Controls colour	Stainless steel	Logo	assembled 50's
Display	electronic 5 buttons	Logo position	Upstand+ Command panel

Programs / Functions

No. of cooking functions 9
 Traditional cooking functions

 Static	 Fan assisted	 Circulaire
 Eco	 Large grill	 Fan grill (large)
 Base	 Fan assisted bottom	 Rotisserie

Cleaning functions

 Vapour Clean

Other functions

 Defrost by time

Hob technical features

			
Total no. of cook zones 5			
Front left - Gas - Rapid - 2.90 kW			
Rear left - Gas - Semi Rapid - 1.80 kW			
Central - Gas - 2UR (dual) - 5.00 kW			
Rear right - Gas - Semi Rapid - 1.80 kW			
Front right - Gas - AUX - 1.00 kW			
Type of gas burners	Standard	Gas safety valves	Yes
Automatic electronic ignition	Yes	Burner caps	Matt black enamelled

Main Oven Technical Features



No. of lights	2	Total no. of door glasses	3
Fan number	2	No. of thermo-reflective door glasses	2
Net volume of the cavity	115 l	Safety Thermostat	Yes
Gross volume, 1st cavity	126 l	Cooling system	Tangential
Cavity material	Ever Clean enamel	Usable cavity space dimensions (HxWxD)	371x724x418 mm
No. of shelves	5	Temperature control	Electro-mechanical
Type of shelves	Metal racks	Lower heating element power	1700 W
Light type	Halogen	Upper heating element - Power	1200 W
Light Power	40 W	Grill element	1700 W
Cooking time setting	Start and Stop	Large grill - Power	2900 W
Light when oven door is open	Yes	Circular heating element - Power	2 x 1550 W
Door opening	Flap down	Grill type	Electric
Removable door	Yes	Tilting grill	Yes
Full glass inner door	Yes	Soft Close system	Yes
Removable inner door	Yes		

Options Main Oven

Timer	Yes	Minimum Temperature	50 °C
		Maximum temperature	260 °C

End of cooking acoustic alarm Yes

Accessories included for Main Oven & Hob



Cast iron wok support	1	40mm deep tray	1
Moka stand in cast iron	1	Grill mesh	1
Rack with back and side stop	1	Telescopic Guide rails, partial Extraction	1
20mm deep tray	1		

Electrical Connection

Plug	(I) Australia	Type of electric cable installed	Yes, Single phase
Electrical connection rating	3200 W	Power supply cable length	120 cm
Current	14 A	Frequency	50/60 Hz
Voltage	220-240 V	Terminal block	3 poles

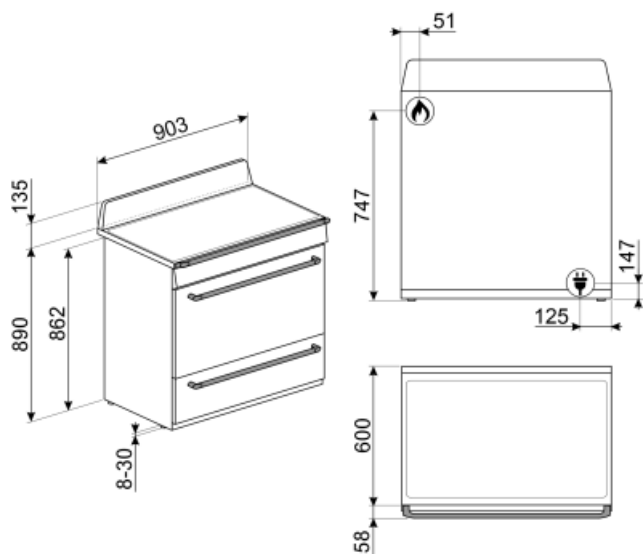

Not included accessories

AIRFRY9

Air fryer rack AIRFRY . Ideal for recreating traditional frying in the oven, but with fewer calories and less fat. It allows you to cook quickly and simply dishes such as French fries, fried vegetables and fish, ensuring perfect browning and crispiness.



PRTX

Refractory pizza stone with handles. D=35cm Not suitable for microwave ovens. Suitable for gas ovens, to be put on the griddle.



KIT1TR9N

Splashback, 90x75 cm suitable for TR9 Victoria cookers, black



KITROT9

Rotisserie kit for 90x60 cookers, new cavity (115 L)



PALPZ

Pizza shovel with fold away handle width: 315mm length : 325mm



SMOLD

Set of 7 silicone moulds for ice creams, ice lollies, pralines, ice cubes or to portion food. Usable from -60°C to +230°C

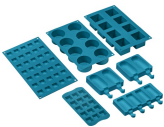

GTP

Partially extractable telescopic guides (1 level) Extraction: 300 mm
Material: Stainless steel AISI 430 polished



PPR9

Refractory pizza stone without handles. Squared shaped stone: L64xH2,3xP37,5 cm Suitable also for gas ovens, to be put on the griddle.



BBQ9



KITHTR90

Height extension kit (950 mm), suitable for Victoria TR90 cookers





















GTT

Totally extractable telescopic guides (1 level) Extraction: 433 mm
Material: Stainless steel AISI 430 polished



Symbols glossary (TT)

 <p>Heavy duty cast iron pan stands: for maximum stability and strength.</p>	 <p>Air cooling system: to ensure a safe surface temperatures.</p>
 <p>Defrost by time: with this function the time of thawing of foods are determined automatically.</p>	 <p>Triple glazed doors: Number of glazed doors.</p>
 <p>Enamel interior: The enamel interior of all Smeg ovens have a special antacid lining which helps keep the interior clean by reducing the amount of cooking grease adhering to it.</p>	 <p>Circogas: In gas ovens the fan distributes the heat quickly and evenly throughout the oven cavity, avoiding flavour transfer when cooking a number of different dishes at the same time. In electric ovens this combination completes cooking more quickly of foods that are ready on the surface, but that require more cooking inside, without further browning.</p>
 <p>Fan with upper and lower elements: The elements combined with the fan aim to provide more uniform heat, a similar method to conventional cooking, so pre-heat is required. Most suitable for items requiring slow cooking methods.</p>	 <p>Upper and lower element only: a traditional cooking method best suited for single items located in the centre of the oven. the top pf the oven will always be hottest. Ideal for roast, fruit cakes, bread etc.</p>
 <p>Lower heating element only: This function is ideal for foods that require extra base temperature without browning, e.g. pastry dishes, pizza. Also suitable for slow cooking of stews and casseroles.</p>	 <p>Circulaire: The combination of the fan and circular element around it gives a hot air cooking method. This provides many benefits including no preheat if cook time is more than 20 minutes, no flavour transfer when cooking different foods at the same time, less energy, and shorter cook times. Good for all types of food.</p>
 <p>ECO: The combination of the grill, fan and lower element is particularly suitable for cooking small quantities of food.</p>	 <p>Grill element: Using of grill gives excellent results when cooking meat of medium and small portions, especially when combined with a rotisserie (where possible). Also ideal for cooking sausages and bacon.</p>
 <p>Fan with grill element: The fan reduces the fierce heat from the grill, providing an excellent method of grilling various foods, chops, steaks, sausages etc. giving even browning and heat distribution, without drying out the food. The top two levels recommended for use, and the lower part of the oven can be used to keep items warm at the same time, an excellent facility when cooking a grilled breakfast. Half grill (centre portion only) is ideal for small quantities of food.</p>	 <p>Rotisserie: The rotisserie (where installed) works in combination with the grill element to brown foods to perfection.</p>
 <p>All glass inner door: All glass inner door, a single flat surface which is simple to keep clean.</p>	 <p>The inner door glass: can be removed with a few quick movements for cleaning.</p>
 <p>Side lights: Two opposing side lights increase visibility inside the oven.</p>	 <p>The oven cavity has 5 different cooking levels.</p>



Soft close: all models are equipped with advanced function of smooth closing of the door, which allows the device to close smoothly and quietly.



Telescopic rails: allow you to pull out the dish and check it without having to remove it from the oven entirely.



Tilting grill: the tilting grill can be easily unhooked to move the heating element and clean the roof of the appliance in one simple step.



Ultra rapid burners: Powerful ultra rapid burners offer up to 5kw of power.



Vapour Clean: a simple cleaning function using steam to loosen deposits in the oven cavity.



The capacity indicates the amount of usable space in the oven cavity in litres.