

TR90IBL2

Cooker size	90x60 cm
N. of cavities with energy label	1
Cavity heat source	ELECTRICITY
Hob type	Induction
Type of main oven	Thermoseal
Cleaning system main oven	Vapour Clean
EAN code	8017709312350
Energy efficiency class	A











Aesthetics

Aesthetic	Victoria	No. of controls	7
Colour	Black	Serigraphy colour	Silver
Finishing	Glossy black	Handle	Smeg Victoria
Design	Victoria	Handle Colour	Polished chrome
Door	With frame	Glass type	Black
Upstand	Yes	Feet	none
Hob colour	Black enamel	Plinth	Anthracite
Command panel finish	Enamelled metal	Storage compartment	Drawer
Control knobs	Smeg Victoria	Sliding compartment	Yes
Controls colour	Stainless steel	Logo	assembled 50's
Display	electronic 5 buttons	Logo position	Upstand+ Command panel
Colour of buttons	Black		

Programs / Functions

No. of cooking functions 9

Traditional cooking functions

 Static	 Fan assisted	 Circulaire
 Eco	 Small grill	 Large grill
 Fan grill (large)	 Base	 Fan assisted bottom

Cleaning functions

Catalytic



Vapour Clean

Other functions



Defrost by time

Hob options



Control lock

Yes

Limited Power

Yes

Consumption Mode

Limited Power

3700, 4800, 7400 W

Consumption Mode in W

Hob technical features



Total no. of cook zones 5

Front left - Induction - single - 1.30 kW - Booster 1.40 kW - Ø 18.0 cm

Rear left - Induction - single - 2.30 kW - Booster 3.00 kW - Ø 21.0 cm

Central - Induction - single - 2.30 kW - Booster 3.00 kW - Ø 27.0 cm

Rear right - Induction - single - 1.30 kW - Booster 1.40 kW - Ø 18.0 cm

Front right - Induction - single - 2.30 kW - Booster 3.00 kW - Ø 21.0 cm

Automatic switch off when overheat

Yes

Minimum pan diameter indication

Yes

Automatic pan detection

Yes

Selected zone indicator

Yes

Main Oven Technical Features



No. of lights

2

Fan number

2

Net volume of the cavity

115 l

Gross volume, 1st cavity

129 l

Cavity material

Ever Clean enamel

No. of shelves

5

Type of shelves

Metal racks

Light type

Halogen

Light Power

40 W

Cooking time setting

Start and Stop

Light when oven door is open

Yes

Door opening

Flap down

Removable door

Yes

Full glass inner door

Yes

Removable inner door

Yes

Total no. of door glasses

3

No. of thermo-reflective door glasses

2

Safety Thermostat

Yes

Cooling system

Tangential

Usable cavity space dimensions (HxWxD)

371x724x418 mm

Temperature control

Electro-mechanical

Lower heating element power

1700 W

Upper heating element - Power

1200 W

Grill element

1700 W

Large grill - Power

2900 W

Circular heating element	1550 W
- Power	
Grill type	Electric
Soft Close system	Yes

Options Main Oven

Timer	Yes	Minimum Temperature	50 °C
End of cooking acoustic alarm	Yes	Maximum temperature	260 °C

Accessories included for Main Oven & Hob

Rack with back and side stop	1	Grill mesh	1
20mm deep tray	1	Catalytic panels	3
40mm deep tray	1		

Electrical Connection

Electrical connection rating	10600 W	Type of electric cable installed	Yes, Single phase
Current	46 A	Type of electric cable	Yes, Double and Three Phase
Voltage	220-240 V	Frequency	50/60 Hz
Voltage 2 (V)	380-415 V	Terminal block	5 poles

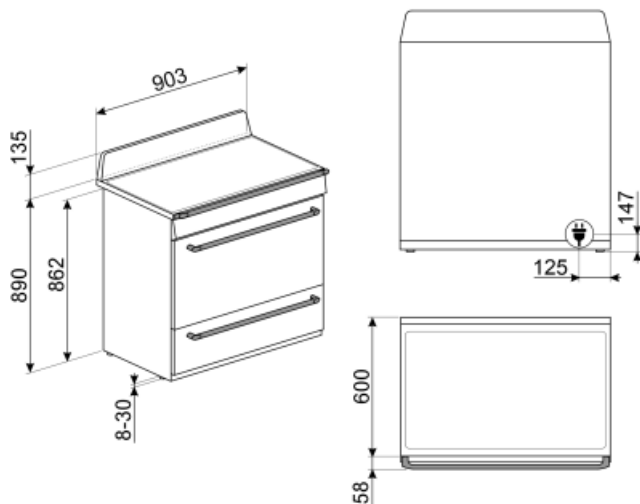

Not included accessories

AIRFRY9

Air fryer rack AIRFRY . Ideal for recreating traditional frying in the oven, but with fewer calories and less fat. It allows you to cook quickly and simply dishes such as French fries, fried vegetables and fish, ensuring perfect browning and crispiness.



PRTX

Refractory pizza stone with handles. D=35cm Not suitable for microwave ovens. Suitable for gas ovens, to be put on the griddle.



PPR9

Refractory pizza stone without handles. Squared shaped stone: L64xH2,3xP37,5 cm Suitable also for gas ovens, to be put on the griddle.



BBQ9



KITHTR90

Height extension kit (950 mm), suitable for Victoria TR90 cookers



PALPZ

Pizza shovel with fold away handle width: 315mm length : 325mm



SMOLD

Set of 7 silicone moulds for ice creams, ice lollies, pralines, ice cubes or to portion food. Usable from -60°C to +230°C

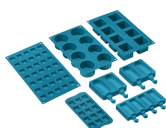

GTP

Partially extractable telescopic guides (1 level) Extraction: 300 mm Material: Stainless steel AISI 430 polished



GRILLPLATE

Universal griddle for induction, gas, ceramic and electric hobs. Non-stick surface ideal for cooking meat, cheese and vegetables. Dimensions: 410 x 240 mm.



KIT1TR9N

Splashback, 90x75 cm suitable for TR9 Victoria cookers, black



SCRP

Induction and ceramic hobs and teppanyaki scraper



TPKPLATE

Universal plate for induction, gas, ceramic and electric hobs. Non-stick surface ideal for cooking fish, eggs and vegetables. Dimensions: 410 X 240 mm.



























GTT

Totally extractable telescopic guides (1 level) Extraction: 433 mm Material: Stainless steel AISI 430 polished



Symbols glossary (TT)

 <p>Child lock: some models are fitted with a device to lock the programme/cycle so it cannot be accidentally changed.</p>	 <p>Air cooling system: to ensure a safe surface temperatures.</p>
 <p>Defrost by time: with this function the time of thawing of foods are determined automatically.</p>	 <p>Triple glazed doors: Number of glazed doors.</p>
 <p>ECO-logic: option allows you to restrict the power limit of the appliance real energy saving.</p>	 <p>A: Product drying performance, measured from A+++ to D / G depending on the product family</p>
 <p>Enamel interior: The enamel interior of all Smeg ovens have a special antacid lining which helps keep the interior clean by reducing the amount of cooking grease adhering to it.</p>	 <p>Circogas: In gas ovens the fan distributes the heat quickly and evenly throughout the oven cavity, avoiding flavour transfer when cooking a number of different dishes at the same time. In electric ovens this combination completes cooking more quickly of foods that are ready on the surface, but that require more cooking inside, without further browning.</p>
 <p>Fan with upper and lower elements: The elements combined with the fan aim to provide more uniform heat, a similar method to conventional cooking, so pre-heat is required. Most suitable for items requiring slow cooking methods.</p>	 <p>Upper and lower element only: a traditional cooking method best suited for single items located in the centre of the oven. the top pf the oven will always be hottest. Ideal for roast, fruit cakes, bread etc.</p>
 <p>Lower heating element only: This function is ideal for foods that require extra base temperature without browning, e.g. pastry dishes, pizza. Also suitable for slow cooking of stews and casseroles.</p>	 <p>Circulaire: The combination of the fan and circular element around it gives a hot air cooking method. This provides many benefits including no preheat if cook time is more than 20 minutes, no flavour transfer when cooking different foods at the same time, less energy, and shorter cook times. Good for all types of food.</p>
 <p>ECO: The combination of the grill, fan and lower element is particularly suitable for cooking small quantities of food.</p>	 <p>Grill element: Using of grill gives excellent results when cooking meat of medium and small portions, especially when combined with a rotisserie (where possible). Also ideal for cooking sausages and bacon.</p>
 <p>Half grill: For rapid cooking and browning of foods. Best results can be obtained by using the top shelf for small items, the lower shelves for larger ones, such as chops or sausages. For half grill heat is generated only at the centre of the element, so is ideal for smaller quantities.</p>	 <p>Fan with grill element: The fan reduces the fierce heat from the grill, providing an excellent method of grilling various foods, chops, steaks, sausages etc. giving even browning and heat distribution, without drying out the food. The top two levels recommended for use, and the lower two part of the oven can be used to keep items warm at the same time, an excellent facility when cooking a grilled breakfast. Half grill (centre portion only) is ideal for small quantities of food.</p>
 <p>Overheat protection: The safety system that automatically turns off the hob in case of overheating of the control unit.</p>	 <p>Induction: The work of these hobs is based on the principle of electromagnetic induction. The heat is generated directly in the bottom of the pan during its contact with the hob.</p>

-
- | | |
|---|---|
|  All glass inner door: All glass inner door, a single flat surface which is simple to keep clean. |  The inner door glass: can be removed with a few quick movements for cleaning. |
|  Side lights: Two opposing side lights increase visibility inside the oven. |  The oven cavity has 5 different cooking levels. |
|  Soft close: all models are equipped with advanced function of smooth closing of the door, which allows the device to close smoothly and quietly. |  Vapour Clean: a simple cleaning function using steam to loosen deposits in the oven cavity. |
|  The capacity indicates the amount of usable space in the oven cavity in litres. | |