

SOA6606WAPNR



Category	60cm
Product Family	Oven
Vitality system	Yes
Power supply	Electric
Heat source	ELECTRICITY
Cooking method	Multitech
Galileo Technology	Omnichef
SmegConnect	Yes
Cleaning system	Vapour Clean
EAN code	8017709313760



Aesthetics

Aesthetic	Dolce Stil Novo	Glass Type	Eclipse
Colour	Black	Door	Full glass
Finishing	Glossy	Handle	Dolce Stil Novo
Design	Flat	Handle Colour	Black
Component finish	Copper	Logo	Applied
Material	Glass		

Controls



Display name	VivoScreen max	No. of display languages	20
Display technology	TFT	Display languages	Italiano, English (UK), Français (FR), Français (CA), Nederlands, Español (ES), Español (MX), Português (PT), Svenska, Русский, Deutsch (DE), Dansk, Norsk, Polski, English (AU), Suomi, Ukrainian, Kazakh, Afrikaans (ZA), Zulu (ZA)
Control setting	Advanced full touch		











Programs / Functions

No. of cooking functions	26
Automatic programmes	150
Steam assisted levels	3 + manual





Customisable recipes

10





Traditional cooking functions

- | | | |
|--|--|---|
|  Static |  Fan assisted |  Circulaire |
|  Turbo |  Eco |  Large grill |
|  Fan grill (large) |  Base |  Circulaire + bottom |
|  Pizza | | |





Cooking functions with pulsed steam

- | | | |
|---|--|---|
|  Fan assisted |  Circulaire |  Circulaire + Bottom |
|  Turbo |  Fan Grill | |





Cooking functions with steam

- | | | |
|--|--|--|
|  Steam |  Fan assisted |  Circulaire |
| Circulaire + bottom |  Sous Vide | |

Other Steam functions

- | | | |
|--|--|---|
|  Tank cleaning |  Water outlet |  Water input |
|  Descaling | | |

Microwave functions













- | | | |
|--|--|--|
|  Microwave |  Fan assisted |  Circulaire |
|  Microwave + grill | Microwavews + Circulaire + bottom | |

Microwave functions

Multitech

Twintech

Other functions

- | | | |
|--|---|--|
|  Defrost by time |  Defrost by weight |  Proving |
|  Stone cooking |  BBQ |  Air-Fry |
|  Melt |  Soft |  Pop-corn |
|  Keep warm |  Plate rack/warmer |  Sabbath |

Cleaning functions

- | |
|---|
|  Vapour Clean |
|---|

Options



Time-setting options	Delay start and automatic end cooking	DeltaT cooking	Yes
Minute minder	Yes	Showroom demo option	Yes
Timer	3	Demo-tutorial mode	Yes
Controls Lock / Child Safety	Yes	Touch guide	Yes
Other options	Keep warm, Eco light, Language setting, Digital clock display, Brightness, Tones, Tones volume	Chronology	Yes, the last 10 functions utilised
Cooking with probe thermometer	Yes	Rapid pre-heating	Yes
Multi-step cooking	Yes, up to 3 steps	Instant GO	Yes
Smart cooking	Yes	Connectivity	WI-FI
SameTime	Yes		

Technical Features



Minimum Temperature	30 °C	Removable inner door	Yes
Maximum temperature	250 °C	Total no. of door glasses	4
No. of shelves	5	Soft Close hinges	Yes
N. of fans	1	Soft Open	Yes
No. of lights	2	Inverter	Yes
Light type	multilevel LED	Stirrer	Si
Light Power	5 W	Chimney	Double
Light when door is opened	Yes	Cooling system	Centrifugal
Lower heating element power	1200 W	Cooling duct	Double
Upper heating element - Power	1000 W	Speed Reduction Cooling System	Yes
Grill element - power	1700 W	Steam range	20 - 100%
Large grill - Power	2700 W	Usable cavity space dimensions (HxWxD)	353x470x397 mm
Circular heating element - Power	2000 W	Temperature control	Electronic
Heating suspended when door is opened	Yes	Cavity material	Ever clean Enamel
Door opening type	Standard opening	Water loading	Fill&Hide 2 , automatic
Door	Cool	Tank capacity	2 l
Full glass inner door	Yes		

Performance / Energy Label



Energy efficiency class	A+	Energy consumption per cycle in fan-forced convection	0.68 kWh
Net volume of the cavity	68 l	Number of cavities	1
Energy consumption per cycle in conventional mode	1.15 kWh	Energy efficiency index	81 %
Energy consumption in conventional mode	4.14 MJ	Microwave effective power	900 W
Energy consumption in forced air convection	2.45 MJ		

Accessories Included



Premium rack	2	St/steel perforated deep tray (40mm)	1
Enamelled deep tray (50mm)	1	Telescopic Guide rails, total Extraction	1
Insert grid	1	Temperature probe	Yes, multipoint
St/steel tray (20mm)	1		

Electrical Connection

Plug	(I) Australia	Nominal power	3000 W
Voltage	220-240 V	Frequency (Hz)	50/60 Hz
Current	13 A	Power supply cable length	150 cm

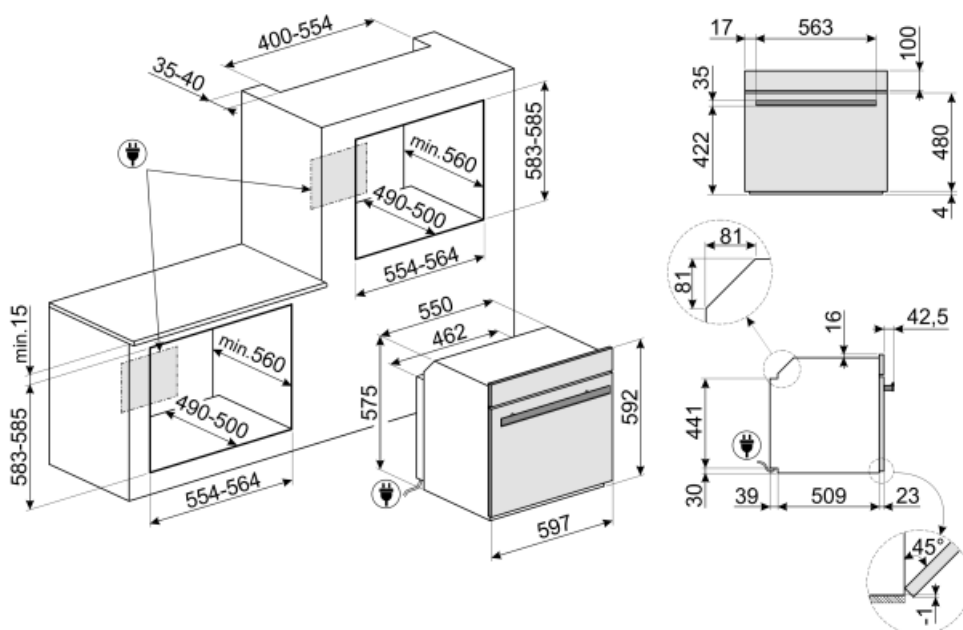

Not included accessories

AIRFRY

Air fryer rack AIRFRY . Ideal for recreating traditional frying in the oven, but with fewer calories and less fat. It allows you to cook quickly and simply dishes such as French fries, fried vegetables and fish, ensuring perfect browning and crispiness.



SFLK1

Child lock



PR3845X

Antifingerprint stainless steel. Cover for furniture in column installation of more ovens



BX640

Stainless steel tray for steam oven, H40xW455xD176 mm



ET20

Enamelled tray, 20mm deep



BBQ

Double sided plate BBQ. Suitable for recreating succulent and crispy dishes in the oven with the typical taste of grilled cooking. The ribbed side is particularly suitable for meats and cheeses. The smooth side for fish, seafood and vegetables.



PALPZ

Pizza shovel with fold away handle width: 315mm length : 325mm



GTP2

Partially extractable telescopic guides (1 level), suitable for traditional ovens. Made in stainless steel, they guarantee stability and facilitate the smooth extraction of the trays.



PR3845N

Black cover for furniture when more ovens are installed in column



BX640PL

Stainless steel perforated tray. To cook many types of vegetables, fish, white meats, ravioli or other varieties of stuffed pasta, preserving all the vitamins and mineral salts for a richer, fuller and natural flavour



ET50

Enamelled tray, 50mm deep



BX640P

Stainless steel perforated tray for steam oven, H40xW455xD176 mm



STONE

Rectangular refractory stone PPR2. Ideal for cooking pizzas with the same results as a typical wood-fired oven. Can also be used for baking bread, focaccias and other recipes such as pies, flans or biscuits Dimensions:L42 x H1,8 x P37,5 cm.





















GTTV2



Totally extractable telescopic guides (1 level), suitable for steam ovens. Made in stainless steel, they guarantee stability and facilitate the smooth extraction of the trays.







Symbols glossary (TT)



 <p>Dedicated cooking function for the double sided plate BBQ. Suitable for recreating succulent and crispy dishes in the oven with the typical taste of g</p>	 <p>...</p>
 <p>Child lock: some models are fitted with a device to lock the programme/cycle so it cannot be accidentally changed.</p>	 <p>The double chimney technology create a special airflow inside the cavity that reduce the condensation inside the cavity during microwave cooking, whe</p>
 <p>...</p>	 <p>Defrost by time: with this function the time of thawing of foods are determined automatically.</p>
 <p>Defrost by weight: With this function the defrosting time is determined</p>	 <p>DeltaT cooking The oven automatically sets the cavity temperature to a predefined temperature (named deltaT) higher than the core temperature detected by the probe. When the probe detects an extra degree at the core, the oven automatically increases also its internal temperature by one degree. The oven offers the possibility to choose between three different deltaT cooking modes (slow, medium and fast) and to set any desired core temperature. A concentration of technology that makes it possible to obtain tender, juicy, healthy products of the highest quality.</p>
 <p>A+: Energy efficiency class A+ helps to save up to 10% energy compared to class A. Maximum performance with minimum consumption is guaranteed.</p>	 <p>Descaling function: Is essential to remove excess deposits of limestone in the tank and allow the proper operation of the product. The need to perform this operation is signaled by the product itself.</p>
 <p>Quadruple glazed: Number of glazed doors.</p>	 <p>Automatic lighting switches off: for greater energy savings, the lighting switches off automatically after one minute from the start of cooking.</p>
 <p>Electric</p>	 <p>Enamel interior: The enamel interior of all Smeg ovens have a special antacid lining which helps keep the interior clean by reducing the amount of cooking grease adhering to it.</p>
 <p>Fresh Touch: Most of Smeg ovens have a "cool door." Thanks to the combination of tangential cooling and internal heat-reflecting glasses, the temperature on the outer surface of the door is maintained below 50° C. In addition to providing safety, this system protects the sides of the furniture from overheating by the oven.</p>	 <p>Fan with upper and lower elements: The elements combined with the fan aim to provide more uniform heat, a similar method to conventional cooking, so pre-heat is required. Most suitable for items requiring slow cooking methods.</p>
 <p>Upper and lower element only: a traditional cooking method best suited for single items located in the centre of the oven. the top pf the oven will always be hottest. Ideal for roast, fruit cakes, bread etc.</p>	 <p>Lower heating element only: This function is ideal for foods that require extra base temperature without browning, e.g. pastry dishes, pizza. Also suitable for slow cooking of stews and casseroles.</p>



-  **Circulaire with lower element:** The addition of the lower element adds extra heat at the base for food which requires extra cooking.



 **Circulaire:** The combination of the fan and circular element around it gives a hot air cooking method. This provides many benefits including no preheat if cook time is more than 20 minutes, no flavour transfer when cooking different foods at the same time, less energy, and shorter cook times. Good for all types of food.
-  **ECO:** The combination of the grill, fan and lower element is particularly suitable for cooking small quantities of food.



 **Grill element:** Using of grill gives excellent results when cooking meat of medium and small portions, especially when combined with a rotisserie (where possible). Also ideal for cooking sausages and bacon.
-  **Fan with grill element:** The fan reduces the fierce heat from the grill, providing an excellent method of grilling various foods, chops, steaks, sausages etc. giving even browning and heat distribution, without drying out the food. The top two levels recommended for use, and the lower part of the oven can be used to keep items warm at the same time, an excellent facility when cooking a grilled breakfast. Half grill (centre portion only) is ideal for small quantities of food.

 **Microwave:** Penetrating straight into the food, microwaves cook very quickly and with considerable energy savings. Suitable for cooking without fat, they are also able to thaw and heat food without altering its original appearance and aroma. The microwave function can also be combined with conventional functions with all the resulting advantages. Ideal for all types of food.
-  **Cooking with the simultaneous use of the heating element in combination with fan and microwave supply.**























 **Microwave + grill element:** The use of the grill results in a perfect browning of the surface of the food. The action of microwaves allows instead of cooking in a short time the internal part of the food.
-  **Fan combined with traditional cooking, where heat is generated from above and below, provides uniform heat. Adding the microwave function allows the same cooking results in less time.**

















 **Pizza function:** The simultaneous operation of three elements ensures an optimum cooking facility when used with the Smeg pizza stone.
-  **FUN_SOUS_VIDE_72dpi**

 **Steam cooking:** it's a natural way of cooking for any kind of products, from vegetables to desserts, to preserve the nutritional and organoleptic properties of ingredients. Ideal for cooking without fat, to heat up food without drying. Steam is ideal for simultaneous cooking of meals that require different cooking times.
-  **Fan combined with traditional cooking, where heat is generated from above and below, provides uniform heat. Adding the steam function allows the same cooking results in less time.**

 **Circulaire element with steam:** Cooking with the simultaneous use of the circular heating element in combination with fan and steam supply.
-  **FUN_STEAM_OTHER_WATER_IN_OUT_72dpi**

 **Circulaire with upper and lower elements:** The use of the fan with both elements allows food to be cooked quickly and effectively, ideal for large joints that require thorough cooking. It offers a similar result to rotisserie, moving the heat around the food, instead of moving the food itself, enabling any size or shape to be cooked.

 <p>Fan with grill with steam assist: For creating a perfectly roasted meat joint. The extra moisture keeps the meat juicy and tender, whilst the heat from the turbo function creates the caramelised flavours we know and love.</p>	 <p>Circulaire with steam assist: Provides extra moisture to food during cooking. Excellent for bread baking. The moisture allows the bread dough to stretch further at the beginning of cooking, creating an aerated and light textured dough. The remaining part of the cooking process allows for the signature crust to form.</p>
 <p>Circulaire + lower element with steam assist: Ideal for reheating flans and quiches. This function will re-crisp the base, whilst filling will not dry out due to the additional moisture in the cooking cavity.</p>	 <p>Circulaire with steam assist: Provides extra moisture to food during cooking. Excellent for bread baking. The moisture allows the bread dough to stretch further at the beginning of cooking, creating an aerated and light textured dough. The remaining part of the cooking process allows for the signature crust to form.</p>
 <p>Turbo with steam assist: For creating a perfectly roasted meat joint. The extra moisture keeps the meat juicy and tender, whilst the heat from the turbo function creates the caramelised flavours we know and love.</p>	 <p>All glass inner door: All glass inner door, a single flat surface which is simple to keep clean.</p>
 <p>The inner door glass: can be removed with a few quick movements for cleaning.</p>	 <p>KEEP_WARM_72dpi</p>
 <p>Warming up: An option for dish warming and keeping the prepared meals hot.</p>	 <p>Cooking with temperature probe: It is possible to display the temperature detected by the probe and set a target temperature that the dish must reach. When the core of the dish reaches the desired temperature, cooking stops</p>
 <p>Air at 40°C provides the perfect environment for proving yeast type dough mixes. Simply select the function and place dough in the cavity for allotted</p>	 <p>Rapid preheat: The rapid preheat function can be used to reach the selected temperature in just a few minutes.</p>
 <p>Sabbath: This function allows you to cook food during the Sabbath, the Holiday of rest in the Jewish religion, respecting the precepts. The oven works</p>	 <p>Touch guide: By holding down any symbol for 3 seconds you can get information on its function</p>
 <p>The oven cavity has 5 different cooking levels.</p>	 <p>Smart Cooking System: for the perfect cooking it is simply necessary choosing the kind and the weight of food and the cooking temperature: any other setting will be established automatically.</p>
 <p>Appliances with Wi-Fi connectivity. Via SmegConnect App is possible to monitor and remotely control appliances through smartphone and tablet (iOS and Android).</p>	 <p>Soft close: all models are equipped with advanced function of smooth closing of the door, which allows the device to close smoothly and quietly.</p>
 <p>Step cooking: It is possible to set up to 3 cooking phases in the same recipe by varying function, time and / or temperature. At the end of a phase the next one will start automatically</p>	 <p>To guarantee the optimal functioning of the appliance, it is suggested to carry out the tank cleaning roughly once every 2-3 months.</p>
 <p>...</p>	 <p>...</p>

- | | | | |
|--|--|---|---|
|  | ... |  | Telescopic rails: allow you to pull out the dish and check it without having to remove it from the oven entirely. |
|  | Electronic control: Allows you to maintain temperature inside the oven with the precision 2-3 ° C. This enables to cook meals that are very sensitive to temperature changes, such as cakes, souffles, puddings. |  | Vapour Clean: a simple cleaning function using steam to loosen deposits in the oven cavity. |
|  | The capacity indicates the amount of usable space in the oven cavity in litres. |  | Wi-Fi connectivity |
|  | ... |  | ... |
|  | ... |  | ... |
|  | ... |  | Dedicated cooking function for the Air fryer rack AIRFRY . Ideal for recreating traditional frying in the oven, but with fewer calories and less fat. |
|  | Dedicated cooking function for the rectangular refractory stone PPR2 Dimensions Ideal for cooking pizzas with the same results as a typical wood-fire |  | Function to melt butter and chocolate without using the bain-marie |
|  | Function to soften butter and cheese It is useful for quickly bringing frozen desserts to serving temperature The function can also be used to soften ice cream |  | Function for the preparation of popcorn packaged in bags |