

# 850mm UNDERMOUNT RANGEHOOD with GLASS FASCIA

SLTC919 L 850



Rangehood type	Undermount
Control	Touch control
Speed settings	4
Ducting diameter	150mm
Extraction type	Onboard motor
Motor	Single aluminium motor
Filter	10mm Stainless steel baffle
Lighting	LED Light strip
Induction Countdown Control	Yes
Electrical requirement	10A
Dimensions (mm)	W850 x D290 x H425-730
Cut-out dimensions (mm)	W835 x D265
Warranty	3 years (6 years when Sirius ducting is used)



**SINGLE  
MOTOR**



**STAINLESS  
STEEL FILTERS**

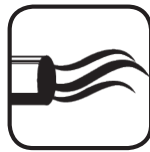

**1020m<sup>3</sup>/h  
AIRFLOW**



**INDUCTION  
SAFE**

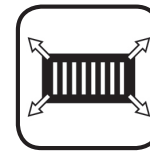

**EXTRA LARGE  
EXTRACTION  
AREA**



**HANDCRAFTED  
IN ITALY**

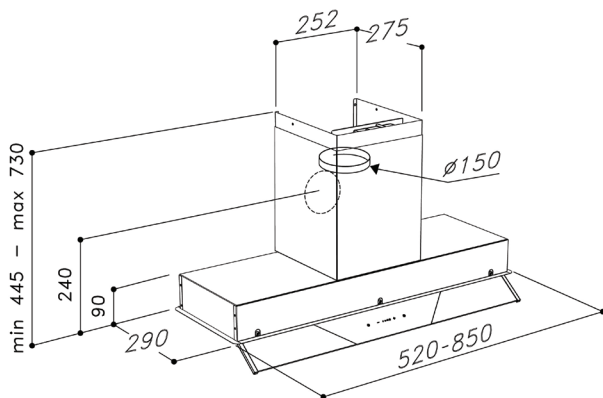

520mm rectangular opening: **265mm x 498mm**

850mm rectangular opening: **265mm x 835mm**

Extra-space 'T-shape' design allows for extra cupboard storage.

Rangehood can be rear-vented.

## Ducting options

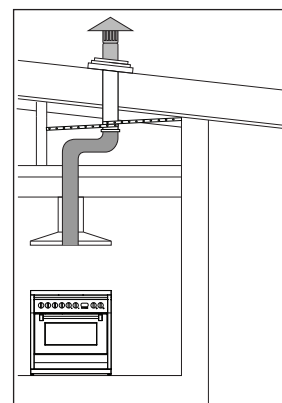

Roof ducted

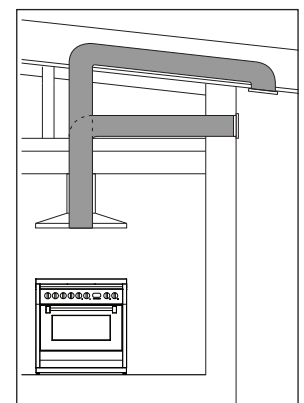

Eave or Wall ducted

- Use semi-rigid or rigid ducting, not fully flexible foil ducting.
- Fewer bends means a quieter and more powerful extraction.
- Extra 3 years warranty when Sirius ducting is used (total 6 years).
- See [support page](#) on Sirius website for installation videos and FAQs.

06/2020

WARNING: technical specifications and product sizes can be varied by the manufacturer, without notice. Cut outs for appliances should only be by physical product measurements. The above information is indicative only.

Distributed by Arisit Pty Ltd