

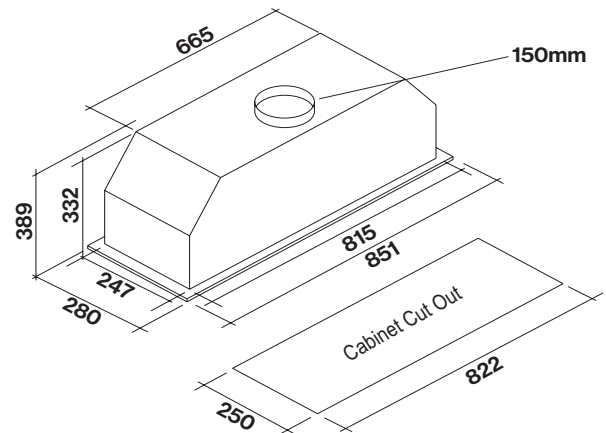

Product Features

Motor Type	On Board Motor
Dimensions	870 x 280 x 363mm Suits 75cm-100cm cooking surfaces
Filtration Type	Baffle Filters x 2
Lighting	Adaptive Dynamic LED Strip
Finish	Surgical grade 304 stainless steel
Frame	Flushmount
Controls	Slim Profile Touch Control (optional remote controller)
Speed Settings	3 Speed + Boost
Timer Function	15 Min Auto Shut-Off
Ducting	150mm Circular Outlet
Installation Info	Quick Install Clips
Other	Brushless Motor

Dimensioned Drawings



Model Code	Motor Output	Installation Option
FP3SN90S2	950m ³ /hr	Top or Back Ducted