

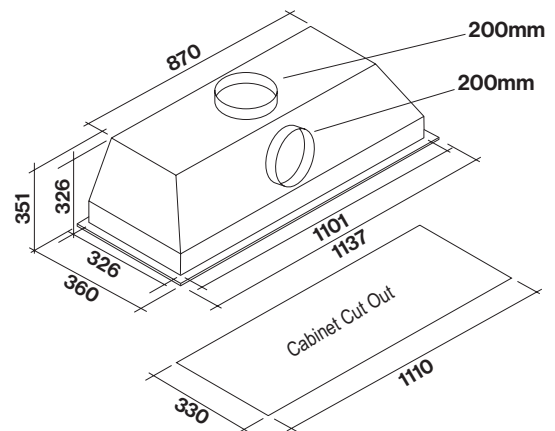

Product Features

Motor Type	Off Board Motor
Dimensions	1137 x 360 x 351mm Suits 90cm-130cm cooking surfaces
Filtration Type	Baffle Filters x 3
Lighting	Adaptive Dynamic LED Strip
Finish	Surgical grade 304 stainless steel
Frame	Flushmount
Controls	Slim Profile Touch Control (optional remote controller)
Speed Settings	3 Speed + Boost
Timer Function	15 Min Auto Shut-Off
Ducting	200mm Circular Outlet + 5m of flexible ducting supplied
Installation Info	Quick Install Clips
Other	N/A

Dimensioned Drawings



Model Code	Motor Output	Motor Solution
FP3MLD12S2-IR1140	1140m ³ /hr	In Roof Motor
FP3MLD12S2-ER1140	1140m ³ /hr	External Roof Motor
FP3MLD12S2-EW1140	1140m ³ /hr	External Wall Motor
FP3MLD12S2-ER2010	2010m ³ /hr	External Roof Motor
FP3MLD12S2-EW2010	2010m ³ /hr	External Wall