

CPF120IGMPBLA

Cooker size	120x60 cm
N. of cavities with energy label	2
Cavity heat source	ELECTRICITY
Hob type	Mixed
Type of main oven	Thermoseal
Type of second oven	Thermoseal
Cleaning system main oven	Pyrolitic
EAN code	8017709289676



Aesthetics











Aesthetic	Portofino	No. of controls	11
Colour	Black	Serigraphy colour	Black
Design	Flush fit	Handle	Smeg Portofino
Door	With frame	Handle Colour	Brushed stainless steel
Upstand	Yes	Glass type	Black
Type of pan stands	Cast Iron	Plinth	Black
Hob colour	Stainless steel	Storage compartment	Drawer
Command panel finish	Finger friendly stainless steel	Sliding compartment	Yes
Control knobs	Smeg Portofino	Logo	Assembled st/steel
Controls colour	Stainless steel	Logo position	Facia below the oven
Display	Touch		

Programs / Functions

No. of cooking functions 9

Traditional cooking functions

 Static	 Fan assisted	 Circulaire
 Turbo	 Eco	 Small grill
 Large grill	 Fan grill (large)	 Fan assisted bottom

Cleaning functions



Pyrolytic

Programs / Functions Auxiliary Oven

Cooking functions cavity 2 8

Traditional cooking functions, cavity 2



Static



Fan assisted



Circulaire



Eco



Large grill



Fan grill (large)



Fan-assisted bottom

Cooking functions with Direct Steam technology



Termo-ventilato (Circolare + Ventola)

Cleaning functions cavity 2

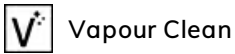

Vapour Clean

Hob technical features



Total no. of cook zones 6

Centrale sinistra - Gas - 2UR (dual) - 4.20 kW

Front centre - Gas - Semi Rapid - 1.80 kW

Rear centre - Gas - Rapid - 3.00 kW

Front right - Induction - multizone - 2.10 kW - Booster 2.30 kW - 21.1x19.1 cm

Rear right - Induction - multizone - 1.60 kW - Booster 1.85 kW - 21.0x19.0 cm

Central - Teppanyaki - 1.40 kW

Type of gas burners	Standard	Automatic pan detection	Yes
Automatic electronic ignition	Yes	Minimum pan diameter indication	Yes
Burner caps	Matt black enamelled	Selected zone indicator	Yes
Automatic switch off when overheat	Yes	Residual heat indicator	Yes

Main Oven Technical Features



No. of lights 2

Fan number 1

Net volume of the cavity 70 l

Total no. of door glasses 4

Gross volume, 1st cavity	79 l	No. of thermo-reflective door glasses	3
Cavity material	Ever Clean enamel	Safety Thermostat	Yes
No. of shelves	5	Heating suspended when door is opened	Yes
Type of shelves	Metal racks	Cooling system	Tangential
Light type	Halogen	Door Lock During Pyrolysis	Yes
Light Power	40 W	Usable cavity space dimensions (HxWxD)	360X460X425 mm
Cooking time setting	Start and Stop	Temperature control	Electro-mechanical
Light when oven door is open	Yes	Lower heating element power	1200 W
Door opening	Flap down	Upper heating element - Power	1000 W
Removable door	Yes	Grill element	1700 W
Full glass inner door	Yes	Large grill - Power	2700 W
Removable inner door	Yes	Circular heating element - Power	2000 W
		Grill type	Electric
		Soft Close system	Yes

Options Main Oven

Timer	Yes	Minimum Temperature	50 °C
End of cooking acoustic alarm	Yes	Maximum temperature	280 °C

Second Oven Technical Features



Net volume of the second cavity	63 l	No. thermo-reflective door glasses	2
Gross volume, 2nd cavity	79 l	Safety Thermostat	Yes
Cavity material	Ever Clean enamel	Heating suspended when door is opened	Yes
No. of shelves	5	Cooling system	Tangential
Type of shelves	Metal racks	Usable cavity space dimensions (HxWxD)	360X460X425 mm
No. of lights	2	Temperature control	Electro-mechanical
Light type	Halogen	Lower heating element - power	1200 W
Light Power	40 W	Upper heating element - Power	1000 W
Cooking time setting	Start and Stop	Grill element - power	1700 W
Light when oven door is open	Yes	Large grill - Power	2700 W
Door opening	Flap down	Circular heating element - Power	2000 W
Removable door	Yes	Grill type	Electric
Full glass inner door	Yes	Tilting grill	Yes
Removable inner door	Yes		
No. total door glasses	3		

Soft Close system Yes

Options Auxiliary Oven

Timer	Yes	Minimum Temperature	50 °C
End of cooking acoustic alarm	Yes	Maximum temperature	260 °C

Accessories included for Main Oven & Hob



Rack with back and side stop	1	Grill mesh	1
20mm deep tray	1	Telescopic Guide rails, total Extraction	1
40mm deep tray	1	Meat Probe	1

Accessories included for Secondary Oven



Rack with back and side stop	1	Grill mesh	1
20mm deep tray	1	Telescopic Guide rails, total Extraction	1
40mm deep tray	1		

Electrical Connection

Electrical connection rating	10900 W	Cable testing	Yes
Current	48 A	Type of electric cable	Yes, Double and Three Phase
Voltage	220-240 V	Frequency	50/60 Hz
Voltage 2 (V)	380-415 V	Terminal block	5 poles
Type of electric cable installed	Yes, Single phase		

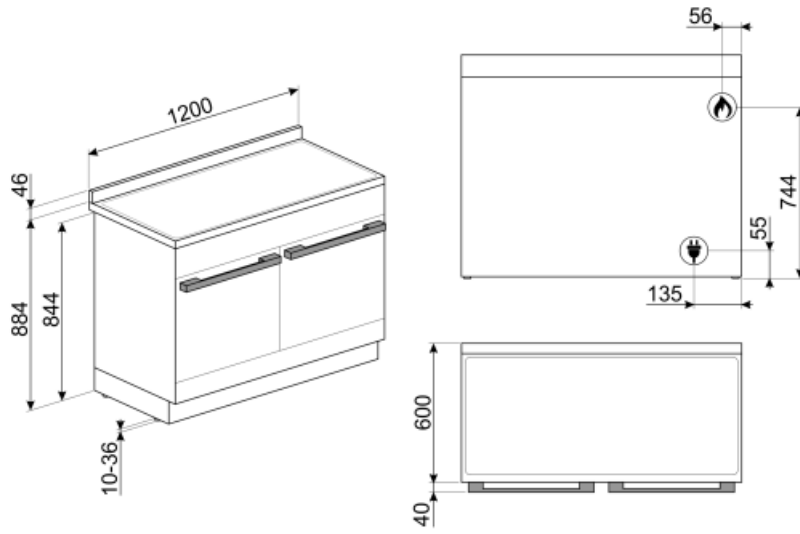

Not included accessories

AIRFRY

Air fryer rack AIRFRY . Ideal for recreating traditional frying in the oven, but with fewer calories and less fat. It allows you to cook quickly and simply dishes such as French fries, fried vegetables and fish, ensuring perfect browning and crispiness.



GTP

Partially extractable telescopic guides (1 level) Extraction: 300 mm Material: Stainless steel AISI 430 polished



BNP608T

Teflon-coated tray, 8mm depth, to be placed on the grid



GRILLPLATE

Universal griddle for induction, gas, ceramic and electric hobs. Non-stick surface ideal for cooking meat, cheese and vegetables. Dimensions: 410 x 240 mm.



BN620-1

Enamelled tray, 20mm deep



SCRP

Induction and ceramic hobs and teppanyaki scraper



KITH95CPF120

Height extension kit (950 mm), suitable for TR4110 cookers



TPKPLATE

Universal plate for induction, gas, ceramic and electric hobs. Non-stick surface ideal for cooking fish, eggs and vegetables. Dimensions: 410 X 240 mm.



SFLK1

Child lock



PRTX

Refractory pizza stone with handles. D=35cm Not suitable for microwave ovens. Suitable for gas ovens, to be put on the griddle.



KITP65CPF120

Depth extension kit (650 mm), suitable for TR4110 cookers



WOKGHU

Cast-Iron WOK Support



KIT1CPF120X

Splashback 120x60 cm, stainless steel, suitable for Portofino cookers



BGTR4110

Cast iron grill plate suitable for Victoria Cookers TR4110



BBQ

Double sided plate BBQ. Suitable for recreating succulent and crispy dishes in the oven with the typical taste of grilled cooking. The ribbed side is particularly suitable for meats and cheeses. The smooth side for fish, seafood and vegetables.



PALPZ

Pizza shovel with fold away handle width: 315mm length : 325mm



GTT

Totally extractable telescopic guides (1 level) Extraction: 433 mm Material: Stainless steel AISI 430 polished



SMOLD



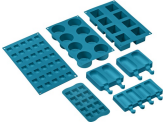













Set of 7 silicone moulds for ice creams, ice lollies, pralines, ice cubes or to portion food. Usable from -60°C to +230°C



















BN640

Enamelled tray, 40mm deep

Symbols glossary (TT)

 <p>Heavy duty cast iron pan stands: for maximum stability and strength.</p>	 <p>Air cooling system: to ensure a safe surface temperatures.</p>
 <p>A DIRECT STEAM oven has 1 steam cooking function to which the user can MANUALLY add steam. The function is activated when the user turns the function knob to the STEAM ON position, and deactivated when the user turns the steam knob to the STEAM OFF position. The user decides at the start of the cooking process how much water to load, up to 250ml. The water in the cavity then becomes steam during the cooking process.</p>	 <p>Triple glazed doors: Number of glazed doors.</p>
 <p>Quadruple glazed: Number of glazed doors.</p>	 <p>ECO-logic: option allows you to restrict the power limit of the appliance real energy saving.</p>
 <p>Enamel interior: The enamel interior of all Smeg ovens have a special antacid lining which helps keep the interior clean by reducing the amount of cooking grease adhering to it.</p>	 <p>Fingerprint proof stainless steel: Fingerprint proof stainless steel keeps stainless steel looking as good as new.</p>
 <p>Circogas: In gas ovens the fan distributes the heat quickly and evenly throughout the oven cavity, avoiding flavour transfer when cooking a number of different dishes at the same time. In electric ovens this combination completes cooking more quickly of foods that are ready on the surface, but that require more cooking inside, without further browning.</p>	 <p>Fan with upper and lower elements: The elements combined with the fan aim to provide more uniform heat, a similar method to conventional cooking, so pre-heat is required. Most suitable for items requiring slow cooking methods.</p>
 <p>Upper and lower element only: a traditional cooking method best suited for single items located in the centre of the oven. the top pf the oven will always be hottest. Ideal for roast, fruit cakes, bread etc.</p>	 <p>Circulaire: The combination of the fan and circular element around it gives a hot air cooking method. This provides many benefits including no preheat if cook time is more than 20 minutes, no flavour transfer when cooking different foods at the same time, less energy, and shorter cook times. Good for all types of food.</p>
 <p>ECO: The combination of the grill, fan and lower element is particularly suitable for cooking small quantities of food.</p>	 <p>Grill element: Using of grill gives excellent results when cooking meat of medium and small portions, especially when combined with a rotisserie (where possible). Also ideal for cooking sausages and bacon.</p>
 <p>Half grill: For rapid cooking and browning of foods. Best results can be obtained by using the top shelf for small items, the lower shelves for larger ones, such as chops or sausages. For half grill heat is generated only at the centre of the element, so is ideal for smaller quantities.</p>	 <p>Fan with grill element: The fan reduces the fierce heat from the grill, providing an excellent method of grilling various foods, chops, steaks, sausages etc. giving even browning and heat distribution, without drying out the food. The top two levels recommended for use, and the lower part of the oven can be used to keep items warm at the same time, an excellent facility when cooking a grilled breakfast. Half grill (centre portion only) is ideal for small quantities of food.</p>

-  **Circulaire with upper and lower elements:** The use of the fan with both elements allows food to be cooked quickly and effectively, ideal for large joints that require thorough cooking. It offers a similar result to rotisserie, moving the heat around the food, instead of moving the food itself, enabling any size or shape to be cooked.
-  **Overheat protection:** The safety system that automatically turns off the hob in case of overheating of the control unit.
-  **The inner door glass:** can be removed with a few quick movements for cleaning.
-  **Pyrolitic:** Pyrolitic cleaning cycles can be selected as necessary to automatically clean the oven interior.
-  **The oven cavity has 5 different cooking levels.**
-  **Telescopic rails:** allow you to pull out the dish and check it without having to remove it from the oven entirely.
-  **Tilting grill:** the tilting grill can be easily unhooked to move the heating element and clean the roof of the appliance in one simple step.
-  **Vapour Clean:** a simple cleaning function using steam to loosen deposits in the oven cavity.
-  **The capacity indicates the amount of usable space in the oven cavity in litres.**
-  **Circulaire with steam assist:** Provides extra moisture to food during cooking. Excellent for bread baking. The moisture allows the bread dough to stretch further at the beginning of cooking, creating an aerated and light textured dough. The remaining part of the cooking process allows for the signature crust to form.
-  **All glass inner door:** All glass inner door, a single flat surface which is simple to keep clean.
-  **Side lights:** Two opposing side lights increase visibility inside the oven.
-  **Indication of residual heat:** After the glass ceramic hob is switched off the residual heat indicator shows which of the heating zones still remains hot. When the temperature drops below 60 ° C, the indicator goes out.
-  **Soft close:** all models are equipped with advanced function of smooth closing of the door, which allows the device to close smoothly and quietly.
-  **Electronic control:** Allows you to maintain temperature inside the oven with the precision 2-3 ° C. This enables to cook meals that are very sensitive to temperature changes, such as cakes, souffles, puddings.
-  **Ultra rapid burners:** Powerful ultra rapid burners offer up to 5kw of power.
-  **The capacity indicates the amount of usable space in the oven cavity in litres.**